

# ZEDV

## L I G H T I N G

### **ASSEMBLY AND INSTALLATION INSTRUCTIONS**

**ITEM NO.: CD10110/4/RCBK**

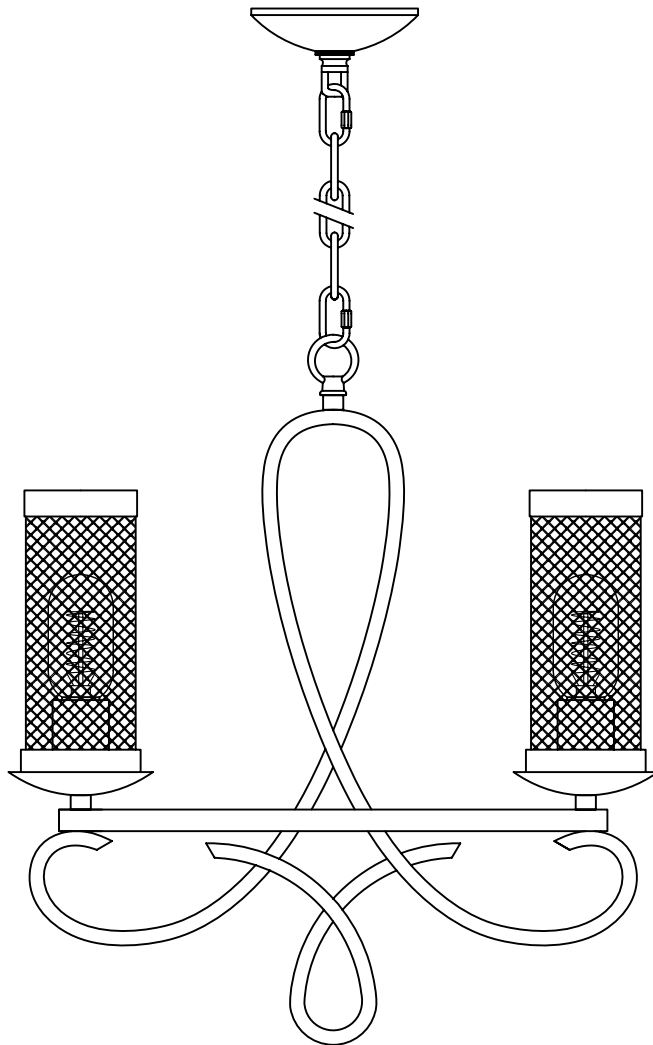

**NOTE:** Before starting installation of this Fixture or the removal of a previous Fixture, disconnect the power by turning off the circuit breaker or removing the fuse from the fuse box.

**STEP 1:** Pass supply wires and ground wire through the metal chain. Unscrew Collar(B) from the Loop(C). Secure the Mounting Strap(D) to the Outlet Box(E) with the Mounting Screws(F). Hand tighten until snug.

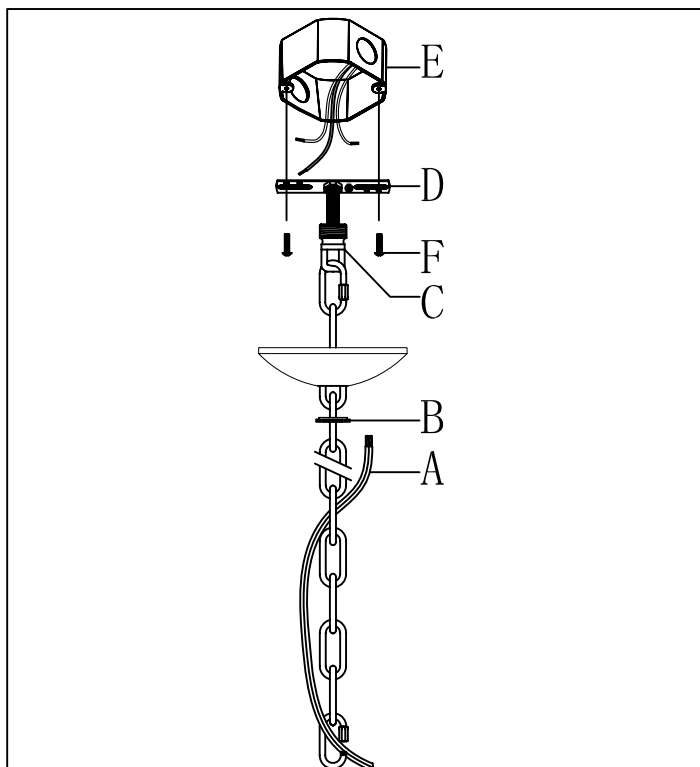

**STEP 2:** Wrap the Ground Wire from the fixture around the Green Ground Screw(G) on the Mounting Strap(D) and then connect the Ribbed Black Wire from the Fixture to the White Wire(Neutral wire) from the Outlet Box. Connect the Smooth Black Wire from the Fixture to the Black Wire(Live wire) from the Outlet Box. Cover the connections using the Wire Connectors(H). Slide Canopy(I) back up the Chain link and screw the Collar(B) back into place.

**NOTE:** Black Wire inside Outlet Box may be red or smooth. White Wire inside Outlet Box may be ribbed.

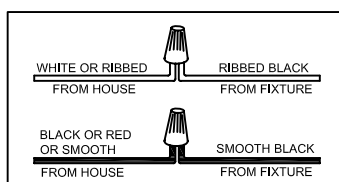
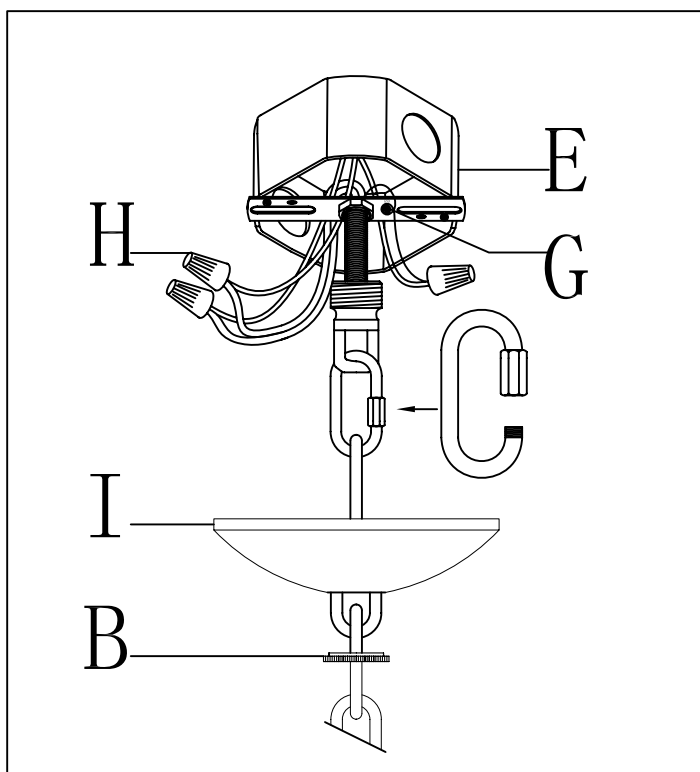

**NOTE:** Before starting installation of this Fixture or the removal of a previous Fixture, disconnect the power by turning off the circuit breaker or removing the fuse from the fuse box.

**STEP 3:** Unscrew the loop lock(J) and put the fixture on the loop lock, then lock it well.

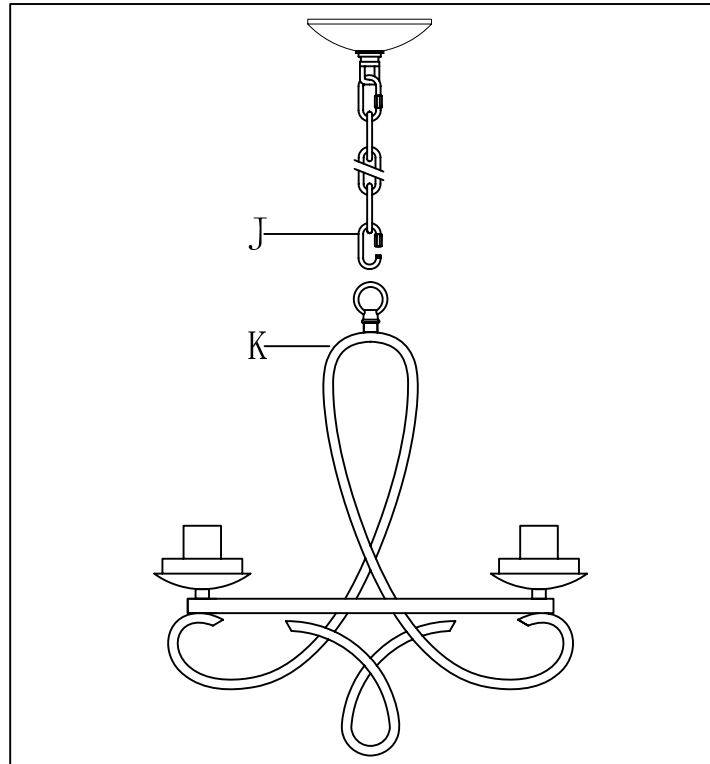

**STEP 4:** Attach the bulb first, then put the mesh shade(L) on the fixture.

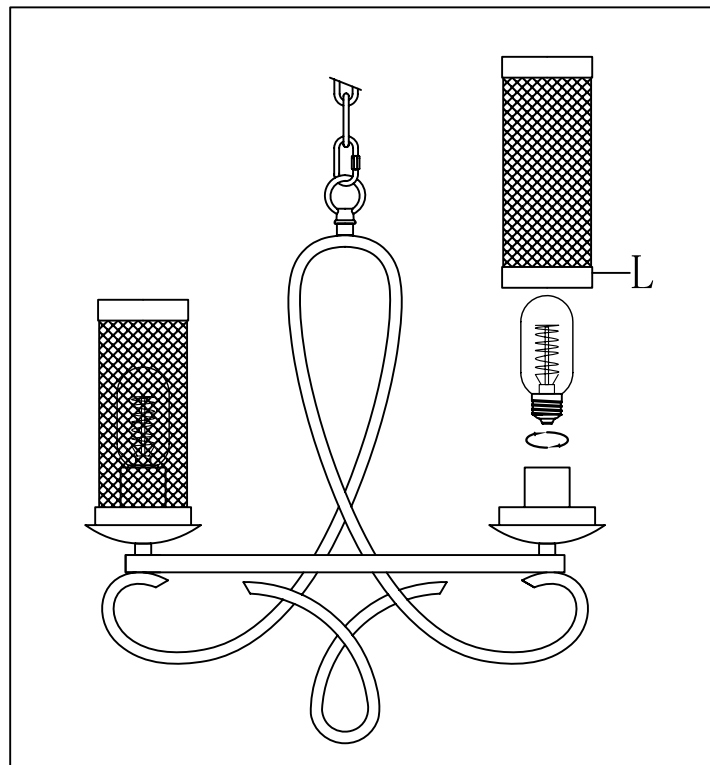

**Cleaning & Care:**

To clean, wipe the Fixture with a soft, dry cloth. Avoid the use of harsh or abrasive chemicals as they may damage the finish.